



DISTRIBUIDORA WAL-MAR

Dirección:

Mar Del Plata

Teléfono:

(0223)643-1207 / 155-909645

Web:

www.distribuidorawalmar.com.ar

E-Mail:

ventas@distribuidorawalmar.com.ar

Fecha de emisión:

11/11/2014 18:14:08

SOPORTES PARA MOTOR



598, AISLADOR CAJA DIRECCION FORD TAUNUS, GACRI-MILLGOM



599, AISLADOR CAJA DIRECCION FORD TAUNUS, GACRI-MILLGOM

422, ANILLO GOMA SOPORTE ESCAPE FIAT 600S, GACRI-MILLGOM



425, ANILLO RESORTE SUSPENSION FIAT 600, GACRI-MILLGOM



431, ANILLO RESORTE SUSPENSION FIAT 600, GACRI-MILLGOM



430, ANTIVIBRADOR PUERTA (CHAPA-GOMA) FIAT 600, GACRI-MILLGOM

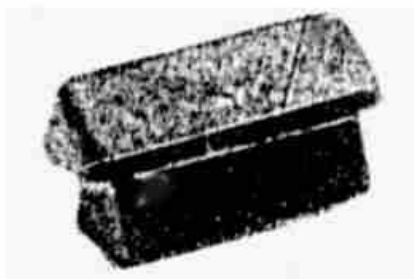

1068, ANTIVIBRADOR RADIADOR FIAT DUNA-UNO, GACRI-MILLGOM



2166, BIELETA BARRA ESTABILIZADORA RENAULT CLIO II-KANGOO (PUNTA), GACRI-MILLGOM



911, BOCHA SUSPENSION RASTROJERO, GACRI-MILLGOM



846, BRAZO PARRILLA DELANTERA PEUGEOT 306 (Ø 19.6 MM.), GACRI-MILLGOM



835, BRAZO PARRILLA DELANTERA PEUGEOT 405 (Ø 18.1 MM.), GACRI-MILLGOM



838, BRAZO PARRILLA DELANTERO PEUGEOT 306 (Ø 18.7 MM.), GACRI-MILLGOM



432, BUJE AMORTIGUADOR (CONICO) FIAT 125-128-1500-1600, GACRI-MILLGOM



433, BUJE AMORTIGUADOR (PLANO) FIAT 600, GACRI-MILLGOM



487, BUJE BARRA ESTAB. FIAT 147-REGATTA (Ø 22 MM.), GACRI-MILLGOM

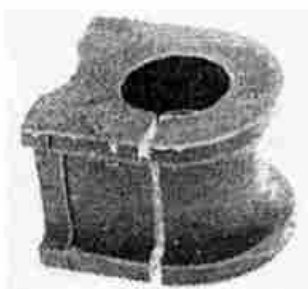

1079, BUJE BARRA ESTAB. FIAT DUNA-UNO (Ø 18 MM.), GACRI-MILLGOM



1080, BUJE BARRA ESTAB. FIAT DUNA-UNO (Ø 19 MM.), GACRI-MILLGOM



1098, BUJE BARRA ESTAB. FIAT PALIO-SIENA (Ø 19 MM.), GACRI-MILLGOM



1098A, BUJE BARRA ESTAB. FIAT PALIO-SIENA (Ø 20 MM.), GACRI-MILLGOM



485, BUJE BARRA ESTAB. FIAT REGATTA (Ø 16 MM.), GACRI-MILLGOM



486, BUJE BARRA ESTAB. FIAT REGATTA (Ø 20 MM.), GACRI-MILLGOM



836, BUJE BARRA ESTAB. PEUGEOT 405 (Ø 20 MM.), GACRI-MILLGOM



837, BUJE BARRA ESTAB. PEUGEOT 405 (Ø 22 MM.), GACRI-MILLGOM



816, BUJE BARRA ESTAB. PEUGEOT 504/1800 (Ø CHICO), GACRI-MILLGOM



815, BUJE BARRA ESTAB. PEUGEOT 504/1800 (Ø GRANDE), GACRI-MILLGOM



818, BUJE BARRA ESTAB. PEUGEOT 504/2000 (Ø CHICO), GACRI-MILLGOM



817, BUJE BARRA ESTAB. PEUGEOT 504/2000 (Ø GRANDE), GACRI-MILLGOM



439, BUJE BARRA ESTAB.FIAT 128 (Ø CHICO), GACRI-MILLGOM



453, BUJE BARRA ESTAB.FIAT 128 (Ø GRANDE), GACRI-MILLGOM



476, BUJE BARRA ESTAB.FIAT 1500, GACRI-MILLGOM



499, BUJE BARRA ESTAB.FIAT DUNA-UNO (Ø 19 MM.), GACRI-MILLGOM

498, BUJE BARRA ESTAB.FIAT DUNA-UNO (Ø 22 MM.), GACRI-MILLGOM

500A, BUJE BARRA ESTAB.TRASERO FIAT DUNA-UNO (Ø 22 MM.), GACRI-MILLGOM



385, BUJE BARRA ESTABILIZADORA PARTE DEL.VW FOX-SURAN-GOL TREND, GACRI-MILLGOM



2305, BUJE BARRA ESTABILIZADORA RENAULT 12, GACRI-MILLGOM



381, BUJE BARRA ESTABILIZADORA VW CARAT-PASSAT (CENTRO), GACRI-MILLGOM



380, BUJE BARRA ESTABILIZADORA VW
CARAT-PASSAT (PUNTA),
GACRI-MILLGOM



375, BUJE BARRA ESTABILIZADORA VW
GACEL-GOL-SAVEIRO-SENDA (CENTRO),
GACRI-MILLGOM



374, BUJE BARRA ESTABILIZADORA VW
GACEL-GOL-SAVEIRO-SENDA (PUNTA),
GACRI-MILLGOM



1103, BUJE BARRA TENSORA FIAT
DUNA-UNO (Ø 22 MM.), GACRI-MILLGOM



484, BUJE BARRA TENSORA FIAT REGATTA
(Ø 16 MM.), GACRI-MILLGOM



882, BUJE BRAZO OSCILANTE
DEL PEUGEOT 504-505,
GACRI-MILLGOM



881, BUJE BRAZO
OSCILANTE PEUGEOT
504-505, GACRI-MILLGOM



1062, BUJE BRAZO REACCION FIAT
DUNA-UNO, GACRI-MILLGOM

459, BUJE CAJA DIRECCION FIAT 128 (JUEGO),
GACRI-MILLGOM



1066, BUJE CAJA DIRECCION FIAT DUNA-UNO (JUEGO), GACRI-MILLGOM



1011, BUJE CHICO SOPORTE MOTOR Y CAJA RENAULT IKA (REPUESTO), GACRI-MILLGOM



1106, BUJE GOMA VARILLA ACEITE FIAT DUNA-UNO, GACRI-MILLGOM



1007, BUJE GRANDE SOPORTE MOTOR DEL.RENAULT IKA ESTANCIERA (REPUESTO), GACRI-MILLGOM



1010, BUJE GRANDE SOPORTE MOTOR DEL.RENAULT IKA JEEP (REPUESTO), GACRI-MILLGOM



5165, BUJE LADO ROTULA OSCILANTE FIAT 128-147-DUNA-UNO, GACRI-MILLGOM



7158, BUJE PARRILLA DEL.PARTE CENTRAL FORD FIESTA-ECOSPORT'03 AD., GACRI-MILLGOM



3

7153, BUJE PARRILLA DEL.PARTE DEL.FORD ESCORT-FIESTA-KA-ORION (BARRILITO), GACRI-MILLGOM



384, BUJE PARRILLA DEL.PARTE DEL.VW FOX-SURAN '06 AD., GACRI-MILLGOM



259, BUJE PARRILLA DEL.PARTE TRAS.CHEVROLET CORSA II-MERIVA, GACRI-MILLGOM



54

7154, BUJE PARRILLA DEL.PARTE TRAS.FORD ESCORT-FIESTA-KA-ORION (PUNTA PESTAÑA), GACRI-MILLGOM



7159, BUJE PARRILLA DEL.PARTE TRAS.FORD FIESTA-ECOSPORT '03 AD., GACRI-MILLGOM

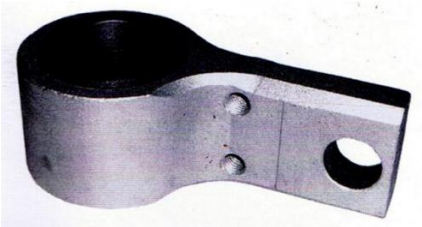

566, BUJE PARRILLA DEL.PARTE TRAS.FORD FIESTA-ECOSPORT '03 AD.(SOP.ALUMINIO), GACRI-MILLGOM



383, BUJE PARRILLA DEL.PARTE TRAS.VW FOX-VENTO-SURAN (PLASTICO), GACRI-MILLGOM



883, BUJE PARRILLA DEL.PEUGEOT 405 (CON PESTAÑA), GACRI-MILLGOM



65

2165, BUJE PARRILLA DEL.RENAULT CLIO II-KANGOO, GACRI-MILLGOM



373, BUJE PARRILLA DEL.VW GOL-SAVEIRO-SENDA-GOLF-CARAT (RANURADO), GACRI-MILLGOM



5141, BUJE PARRILLA DELANTERA FIAT DUCATO CON CHAPA, GACRI-MILLGOM



7155, BUJE PARRILLA DELANTERA FORD COURIER-FIESTA (CENTRAL), GACRI-MILLGOM



5141, BUJE PARRILLA DELANTERA PEUGEOT BOXER CON CHAPA, GACRI-MILLGOM



5118, BUJE PARRILLA DELANTERO FIAT DUCATO, GACRI-MILLGOM

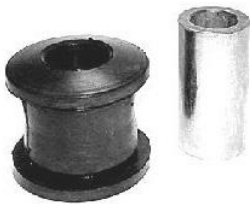

5118, BUJE PARRILLA DELANTERO PEUGEOT BOXER, GACRI-MILLGOM



379, BUJE PARRILLA INF.DEL.PARTE DEL.VW BORA-CADDY-GOLF-NEW BEETLE-PASSAT-POLO, GACRI-MILLGOM



378, BUJE PARRILLA INF.DEL.PARTE TRAS.VW BORA-GOLF-NEW BEETLE, GACRI-MILLGOM



377, BUJE PARRILLA INF.DEL.PARTE TRAS.VW BORA-GOLF-NEW BEETLE '99 AD., GACRI-MILLGOM



376, BUJE PARRILLA INF.DEL.PARTE TRAS.VW CADDY-GOLF-PASSAT-POLO, GACRI-MILLGOM



2167, BUJE PARRILLA INFERIOR DEL.RENAULT 21 (LISO), GACRI-MILLGOM



5

382, BUJE PARRILLA INFERIOR DEL.VW
CARAT-QUANTUM, GACRI-MILLGOM



261, BUJE PARRILLA INFERIOR PARTE
DEL.CHEVROLET VECTRA,
GACRI-MILLGOM



35

260, BUJE PARRILLA INFERIOR PARTE
TRAS.CHEVROLET VECTRA,
GACRI-MILLGOM



2308, BUJE PARRILLA RENAULT 19,
GACRI-MILLGOM



2168, BUJE PARRILLA RENAULT 21
(ESTAMPADO), GACRI-MILLGOM



2164, BUJE PARRILLA RENAULT CLIO
(CON CUELLO), GACRI-MILLGOM



2163, BUJE PARRILLA RENAULT CLIO
(LISO), GACRI-MILLGOM



6

7156, BUJE PARRILLA SUPERIOR
DEL.PARTE TRAS.FORD COURIER-FIESTA
97/98, GACRI-MILLGOM



7

7157, BUJE PARRILLA SUPERIOR
DEL.PARTE TRAS.FORD
COURIER-FIESTA '98, GACRI-MILLGOM



5

885, BUJE PARRILLA SUSPENSION DEL.PEUGEOT 206 (CENTRO), GACRI-MILLGOM



86

886, BUJE PARRILLA SUSPENSION DEL.PEUGEOT 206-307 (PUNTA CON PESTAÑA), GACRI-MILLGOM



4

884, BUJE PARRILLA SUSPENSION DEL.PEUGEOT 306-PARTNER (CON PESTAÑA), GACRI-MILLGOM



7

887, BUJE PARRILLA SUSPENSION DEL.PEUGEOT 307 (CENTRO), GACRI-MILLGOM



5162, BUJE PARRILLA TRASERA FIAT 147-DUNA-UNO (LARGO), GACRI-MILLGOM



5164, BUJE PARRILLA TRASERA FIAT DUNA-FIORINO-UNO (LADO EJE), GACRI-MILLGOM



5163, BUJE PARRILLA TRASERA FIAT DUNA-FIORINO-UNO (LADO RUEDA-PESTAÑA U), GACRI-MILLGOM



1061, BUJE PARRILLA TRASERA FIAT REGATTA WEEKEND, GACRI-MILLGOM



372, BUJE PUNTA BARRA DIRECCION VW GOL-SAVEIRO-SENDA-GOLF-CARAT, GACRI-MILLGOM



1074, BUJE PUNTA BARRA ESTAB.FIAT
TEMPRA-PALIO-SIENA, GACRI-MILLGOM



5150, BUJE SUSPENSION SILENT BLOCK
FIAT PALIO-SIENA, GACRI-MILLGOM

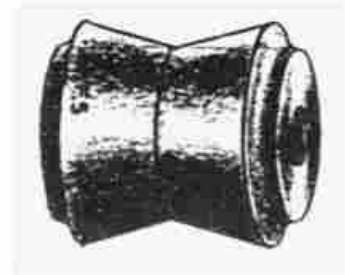

500, BUJE TENSOR DELANTERO FIAT
DUNA-UNO, GACRI-MILLGOM



2304, BUJE TENSOR DELANTERO
RENAULT 12, GACRI-MILLGOM



1027, BUJE TENSOR DELANTERO
RENAULT 4L-6, GACRI-MILLGOM



152

7152, BUJE TENSOR
DELANTERO-TRASERO FORD ESCORT,
GACRI-MILLGOM



474, BUJE TENSOR DIRECCION FIAT
125-1500-1600 (JUEGO), GACRI-MILLGOM



488, BUJE TENSOR FIAT 128,
GACRI-MILLGOM



1096, BUJE TENSOR FIAT DUCATO,
GACRI-MILLGOM



468, BUJE TENSOR FIAT DUNA-UNO (Ø 14
MM.), GACRI-MILLGOM



480, BUJE TENSOR FIAT REGATTA (Ø 12
MM.), GACRI-MILLGOM



483, BUJE TENSOR FIAT REGATTA 85
(CON ARANDELA), GACRI-MILLGOM



543, BUJE TENSOR FORD F100 PICK UP 66/69, GACRI-MILLGOM



542, BUJE TENSOR FORD FALCON 62/83, GACRI-MILLGOM



825, BUJE TENSOR PEUGEOT 505, GACRI-MILLGOM



524A, BULON SOPORTE CAJA FORD CON MOTOR PERKINS, GACRI-MILLGOM



409, CAPUCHON ACOPLA PALIER FIAT 600, GACRI-MILLGOM



1071, CAPUCHON TIRANTE PALANCA CAMBIOS FIAT DUNA-UNO, GACRI-MILLGOM



2121, CAZOLETA AMORTIGUADOR DEL. RENAULT CLIO, GACRI-MILLGOM



2122, CAZOLETA AMORTIGUADOR DEL. RENAULT TWINGO, GACRI-MILLGOM



3164, CAZOLETA AMORTIGUADOR DEL.FORD FOCUS, GACRI-MILLGOM



574, CAZOLETA AMORTIGUADOR DELANTERA FORD ESCORT-ORION, GACRI-MILLGOM



438, CAZOLETA AMORTIGUADOR FIAT 128/1100-1300, GACRI-MILLGOM



572, CAZOLETA AMORTIGUADOR FORD ESCORT-ORION, GACRI-MILLGOM



625, CAZOLETA AMORTIGUADOR
MERCEDES BENZ SPRINTER,
GACRI-MILLGOM



626, CAZOLETA AMORTIGUADOR
MERCEDES BENZ SPRINTER,
GACRI-MILLGOM



880, CAZOLETA AMORTIGUADOR
PEUGEOT 206, GACRI-MILLGOM



879, CAZOLETA AMORTIGUADOR
PEUGEOT 306-PARTNER, GACRI-MILLGOM



811, CAZOLETA AMORTIGUADOR
PEUGEOT 404-504, GACRI-MILLGOM



854, CAZOLETA AMORTIGUADOR
PEUGEOT 405, GACRI-MILLGOM



850, CAZOLETA AMORTIGUADOR
PEUGEOT 405 82/86, GACRI-MILLGOM



851, CAZOLETA AMORTIGUADOR
PEUGEOT 505 '86 AD., GACRI-MILLGOM



2307, CAZOLETA AMORTIGUADOR
RENAULT 11, GACRI-MILLGOM



2311, CAZOLETA AMORTIGUADOR
RENAULT 19-MEGANE-CLIO-SCENIC,
GACRI-MILLGOM



2115, CAZOLETA AMORTIGUADOR
RENAULT EXPRESS (SOLO CHAPA),
GACRI-MILLGOM



2116, CAZOLETA AMORTIGUADOR
RENAULT EXPRESS (SOLO GOMA),
GACRI-MILLGOM



1048, CAZOLETA AMORTIGUADOR
RENAULT TRAFIC, GACRI-MILLGOM



3868, CAZOLETA AMORTIGUADOR VW
GOL-GACEL (CON RODAMIENTO),
GACRI-MILLGOM



3869, CAZOLETA AMORTIGUADOR VW
GOL-GACEL-SAVEIRO-SENDA,
GACRI-MILLGOM



3870, CAZOLETA AMORTIGUADOR VW
GOL-SAVEIRO (CON RODAMIENTO),
GACRI-MILLGOM



457, CAZOLETA AMORTIGUADOR FIAT
REGATTA 85, GACRI-MILLGOM



2117, CAZOLETA DELANTERA RENAULT
CLIO II-KANGOO, GACRI-MILLGOM



807, CONTRAPESO CAJA DERECHO
PEUGEOT 404-504 (CORTO),
GACRI-MILLGOM



808, CONTRAPESO CAJA IZQUIERDO
PEUGEOT 404-504 (LARGO),
GACRI-MILLGOM



809, CONTRAPESO CAJA PEUGEOT
504-505 (MARTILLO CORTO),
GACRI-MILLGOM



810, CONTRAPESO CAJA PEUGEOT
504-505 (MARTILLO LARGO),
GACRI-MILLGOM



5140, CUBRE PEDAL ACELERADOR FIAT
DUNA-UNO-REGATTA, GACRI-MILLGOM

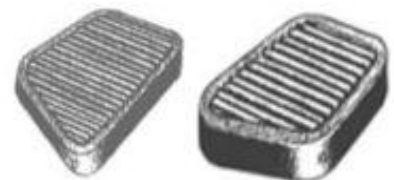

410, CUBRE PEDAL DERECHO-IZQUIERDO
FIAT 600 (JUEGO), GACRI-MILLGOM



440, CUBRE PEDAL FRENO-EMBRAGUE FIAT 128, GACRI-MILLGOM



475, CUBRE PEDAL FRENO-EMBRAGUE FIAT 1500, GACRI-MILLGOM

494, CUBRE PEDAL FRENO-EMBRAGUE FIAT DUNA-UNO-PALIO-SIENA-REGATTA, GACRI-MILLGOM



849, CUBRE PEDAL FRENO-EMBRAGUE PEUGEOT 404, GACRI-MILLGOM



852, CUBRE PEDAL FRENO-EMBRAGUE PEUGEOT 505, GACRI-MILLGOM

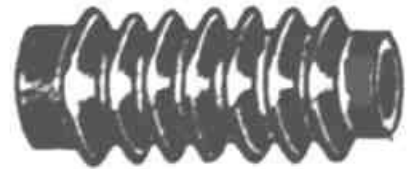

458, FUELLE SELECTORA PALANCA CAMBIOS FIAT 128, GACRI-MILLGOM



1070, FUELLE TIRANTE PALANCA CAMBIOS FIAT DUNA-UNO, GACRI-MILLGOM



540, GOMA ALOJAMIENTO CARDAN FORD TAUNUS-SIERRA, GACRI-MILLGOM



1072, GOMA APOYO ESPIRAL FIAT DUNA-UNO GRANDE, GACRI-MILLGOM



1067, GOMA APOYO ESPIRAL FIAT DUNA-UNO HASTA '91, GACRI-MILLGOM



412, GOMA CANALIZADOR AIRE FIAT 600, GACRI-MILLGOM



1006, GOMA SOPORTE CAJA RENAULT IKA JEEP-ESTANCIERA-GLADIATOR (REPUESTO), GACRI-MILLGOM



1075, GOMA SOPORTE RADIADOR SUPERIOR FIAT DUNA-UNO, GACRI-MILLGOM



1076, GOMA TIRANTE CRIQUE FIAT DUNA-UNO, GACRI-MILLGOM

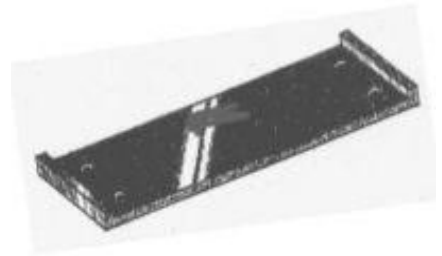

423, GOMA TIRANTE PUERTA FIAT 600, GACRI-MILLGOM



413, GOMA VARILLA ACEITE FIAT 128-147-DUNA-UNO, GACRI-MILLGOM



607, GUARDAPOLVO PALANCA CAMBIOS MERCEDES BENZ CAMION, GACRI-MILLGOM



855, KIT REPARACION PARRILA PEUGEOT 306-PARTNER (Ø 18.7 MM.), GACRI-MILLGOM



856, KIT REPARACION PARRILA PEUGEOT 306-PARTNER (Ø 19.6 MM.), GACRI-MILLGOM



442, MANCHON PALANCA CAMBIOS FIAT 128/1100 (Ø CHICO), GACRI-MILLGOM



443, MANCHON PALANCA CAMBIOS FIAT 128/1300 (GRANDE), GACRI-MILLGOM



415, MANCHON PALANCA CAMBIOS FIAT 600, GACRI-MILLGOM



416, MANCHON PALANCA CAMBIOS FIAT 600 (REGULABLE), GACRI-MILLGOM



2243, MANCHON PALANCA CAMBIOS FIAT SPAZIO-FIORINO, GACRI-MILLGOM



606, PROTECTOR RULEMAN CARDAN
MERCEDES BENZ 608-1114-3500,
GACRI-MILLGOM



1024, REPUESTOS PARA SOPORTE
MOTOR N° 1022-1023-1029-1030,
GACRI-MILLGOM



460, SOPORTE ALOJAMIENTO CARDAN
FIAT 125-1600, GACRI-MILLGOM



470, SOPORTE ALOJAMIENTO CARDAN
FIAT 1500, GACRI-MILLGOM



178

878, SOPORTE AMORTIGUADOR
DEL. PEUGEOT 307, GACRI-MILLGOM



371, SOPORTE AMORTIGUADOR DEL.VW
POLO, GACRI-MILLGOM



1064, SOPORTE AMORTIGUADOR
DELANTERO FIAT DUNA-UNO,
GACRI-MILLGOM



5148, SOPORTE AMORTIGUADOR
DERECHO FIAT PALIO-SIENA,
GACRI-MILLGOM



573, SOPORTE AMORTIGUADOR FORD
ESCORT '96 AD., GACRI-MILLGOM



569, SOPORTE AMORTIGUADOR FORD
FIESTA-KA-COURRIER '96,
GACRI-MILLGOM



3166, SOPORTE AMORTIGUADOR FORD
MONDEO, GACRI-MILLGOM

5149, SOPORTE AMORTIGUADOR IZQUIERDO
FIAT PALIO-SIENA, GACRI-MILLGOM



258, SOPORTE AMORTIGUADOR SUPERIOR CHEVROLET CORSA, GACRI-MILLGOM



1091, SOPORTE AMORTIGUADOR TRASERO FIAT DUNA-UNO, GACRI-MILLGOM



1088, SOPORTE AMORTIGUADOR TRASERO FIAT DUNA-UNO '94 AD., GACRI-MILLGOM



3151, SOPORTE AMORTIGUADOR TRASERO FORD KA '97 AD., GACRI-MILLGOM



370, SOPORTE AMORTIGUADOR VW POINTER, GACRI-MILLGOM



456, SOPORTE APOYO RADIADOR FIAT 600, GACRI-MILLGOM



842, SOPORTE BARRA ESTAB. PEUGEOT 306 (Ø 18 MM.), GACRI-MILLGOM



843, SOPORTE BARRA ESTAB. PEUGEOT 306 (Ø 19 MM.), GACRI-MILLGOM



844, SOPORTE BARRA ESTAB. PEUGEOT 306 (Ø 20 MM.), GACRI-MILLGOM



845, SOPORTE BARRA ESTAB. PEUGEOT 306 (Ø 21 MM.), GACRI-MILLGOM



1099, SOPORTE BASE CARBURADOR FIAT DUNA-UNO (2 BOCAS), GACRI-MILLGOM



1099B, SOPORTE BASE CARBURADOR FIAT DUNA-UNO 1.4 (1 BOCA), GACRI-MILLGOM



830, SOPORTE BUJE CENTRAL MOTOR
PEUGEOT 405, GACRI-MILLGOM

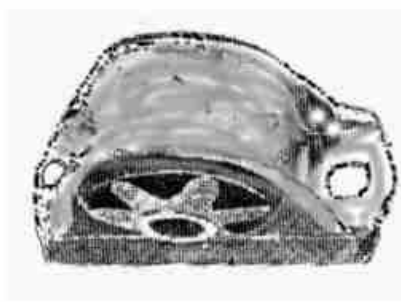

1078, SOPORTE BUJE TENSOR FIAT
TEMPRA, GACRI-MILLGOM



349, SOPORTE CAÑO ESCAPE (ANILLO)
VW GOL-GOLF, GACRI-MILLGOM



4121, SOPORTE CAÑO ESCAPE
(SILENCIADOR) RENAULT CLIO-MEGANE,
GACRI-MILLGOM



347, SOPORTE CAÑO ESCAPE
(SILENCIADOR) VW POINTER,
GACRI-MILLGOM



345, SOPORTE CAÑO ESCAPE
(SILENCIADOR) VW
GOL-GACEL-SAVEIRO-SENDA,
GACRI-MILLGOM



451, SOPORTE CAÑO ESCAPE FIAT 128
(CON GANCHO), GACRI-MILLGOM



452, SOPORTE CAÑO ESCAPE FIAT
128-147 (ROMBO), GACRI-MILLGOM



493A, SOPORTE CAÑO ESCAPE FIAT
147-DUNA-UNO-REGATTA (ANILLO),
GACRI-MILLGOM



492, SOPORTE CAÑO ESCAPE FIAT
147-DUNA-UNO-REGATTA (COLA),
GACRI-MILLGOM



493, SOPORTE CAÑO ESCAPE FIAT
147-DUNA-UNO-REGATTA (INTERMEDIO),
GACRI-MILLGOM



5137, SOPORTE CAÑO ESCAPE FIAT
PALIO, GACRI-MILLGOM



5138, SOPORTE CAÑO ESCAPE FIAT PALIO-PALIO WEEKEND-SIENA, GACRI-MILLGOM



1102, SOPORTE CAÑO ESCAPE FIAT PALIO-SIENA, GACRI-MILLGOM



482, SOPORTE CAÑO ESCAPE FIAT REGATTA (ANILLO), GACRI-MILLGOM



481, SOPORTE CAÑO ESCAPE FIAT REGATTA (CON GANCHO), GACRI-MILLGOM



495, SOPORTE CAÑO ESCAPE FIAT REGATTA (ROMBO), GACRI-MILLGOM



583, SOPORTE CAÑO ESCAPE FORD TAUNUS, GACRI-MILLGOM



847, SOPORTE CAÑO ESCAPE PEUGEOT 206, GACRI-MILLGOM



813, SOPORTE CAÑO ESCAPE PEUGEOT 404, GACRI-MILLGOM



814, SOPORTE CAÑO ESCAPE PEUGEOT 504, GACRI-MILLGOM



909, SOPORTE CAÑO ESCAPE RASTROJERO, GACRI-MILLGOM



1034, SOPORTE CAÑO ESCAPE RENAULT 12 (GRANDE), GACRI-MILLGOM



1043, SOPORTE CAÑO ESCAPE RENAULT 18 (ANILLO SOLO), GACRI-MILLGOM



1042, SOPORTE CAÑO ESCAPE RENAULT 18 (CON GANCHO), GACRI-MILLGOM



4087, SOPORTE CAÑO ESCAPE RENAULT 19, GACRI-MILLGOM



1054, SOPORTE CAÑO ESCAPE RENAULT 21, GACRI-MILLGOM



1028, SOPORTE CAÑO ESCAPE RENAULT 4-6-12, GACRI-MILLGOM

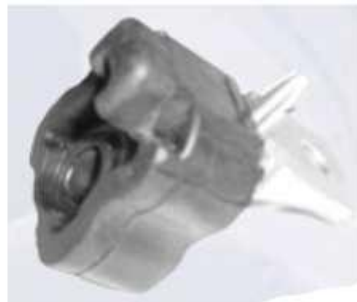

4120, SOPORTE CAÑO ESCAPE RENAULT CLIO-MEGANE, GACRI-MILLGOM



1012, SOPORTE CAÑO ESCAPE RENAULT IKA, GACRI-MILLGOM



344, SOPORTE CAÑO ESCAPE VW GOL-GACEL-SAVEIRO-SENDA, GACRI-MILLGOM



348, SOPORTE CAÑO ESCAPE VW GOL-GOLF, GACRI-MILLGOM



266, Soporte caño de escape Chevrolet corsa, GACRI-MILLGOM



315, SOPORTE CAÑO ESCAPE SIAM DI TELLA, GACRI-MILLGOM



112, SOPORTE CABINA BEDFORD '64 AD., GACRI-MILLGOM



227, SOPORTE CABINA CHEVROLET BEDFORD CAMION, GACRI-MILLGOM



226, SOPORTE CABINA CHEVROLET
BEDFORD CAMION 350 69/70,
GACRI-MILLGOM



535, SOPORTE CABINA DELANTERO
(TROMPA) FORD F100 73/81 (JUEGO),
GACRI-MILLGOM



538, SOPORTE CABINA DELANTERO
(TROMPA) FORD F100 '81 AD.(JUEGO),
GACRI-MILLGOM



536, SOPORTE CABINA DELANTERO FORD
F100 73/81 (JUEGO), GACRI-MILLGOM



366, SOPORTE CABINA INFERIOR BAJO
VW DODGE D100-CAMION,
GACRI-MILLGOM



553, SOPORTE CABINA INFERIOR FORD
7000-14000, GACRI-MILLGOM



616, SOPORTE CABINA INFERIOR
MERCEDES BENZ 1112-1114,
GACRI-MILLGOM



368, SOPORTE CABINA INTERIOR VW
DODGE D100-CAMION, GACRI-MILLGOM



605, SOPORTE CABINA MERCEDES BENZ
1112-1114-3500, GACRI-MILLGOM



554, SOPORTE CABINA RADIADOR BAJO FORD F100-7000 (JUEGO), GACRI-MILLGOM



243, SOPORTE CABINA SUP. TRASERO CHEVROLET CAMION '66 AD., GACRI-MILLGOM



552, SOPORTE CABINA SUPERIOR FORD 7000-14000, GACRI-MILLGOM



615, SOPORTE CABINA SUPERIOR MERCEDES BENZ 1112-1114, GACRI-MILLGOM



367, SOPORTE CABINA SUPERIOR VW DODGE D100-CAMION, GACRI-MILLGOM



230, SOPORTE CABINA TRASERO CHEVROLET PICK UP 67/73, GACRI-MILLGOM



537, SOPORTE CABINA TRASERO FORD F100 73/81 (JUEGO), GACRI-MILLGOM



539, SOPORTE CABINA TRASERO FORD F100 '81 AD.(JUEGO), GACRI-MILLGOM

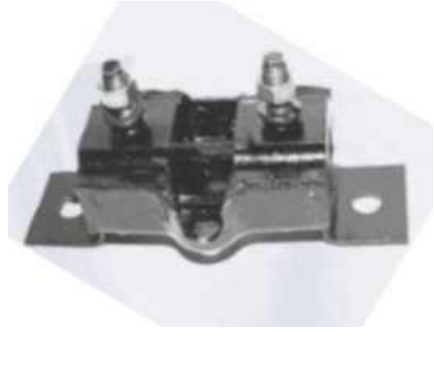

506, SOPORTE CAJA AUTOMATICA FORD FALCON, GACRI-MILLGOM



220, SOPORTE CAJA CHEVROLET
400-CHEVY-PICK UP 62/76,
GACRI-MILLGOM



250, SOPORTE CAJA CHEVROLET
BLAZER-S10, GACRI-MILLGOM



229, SOPORTE CAJA CHEVROLET OPEL
K180, GACRI-MILLGOM



246, SOPORTE CAJA CHEVROLET PICK UP
D10-20 TODAS, GACRI-MILLGOM



351, SOPORTE CAJA DELANTERO VW
KOMBI, GACRI-MILLGOM



477, SOPORTE CAJA FIAT 125-1500-1600,
GACRI-MILLGOM



444, SOPORTE CAJA FIAT 128/1100 (SIN
TUERCA), GACRI-MILLGOM



445, SOPORTE CAJA FIAT 128/1300 (CON
TUERCA), GACRI-MILLGOM



446, SOPORTE CAJA FIAT 128/1300 SUPER
EUROPA (CON TUERCA), GACRI-MILLGOM



447, SOPORTE CAJA FIAT 128/1500 SUPER
EUROPA (SIN TUERCA), GACRI-MILLGOM



491, SOPORTE CAJA FIAT 147-SPAZIO
DIESEL, GACRI-MILLGOM



490, SOPORTE CAJA FIAT 147-SPAZIO
NAFTA, GACRI-MILLGOM



417, SOPORTE CAJA FIAT 600,
GACRI-MILLGOM



1097, SOPORTE CAJA FIAT DUCATO,
GACRI-MILLGOM



5119, SOPORTE CAJA FIAT DUCATO
MODELO NUEVO, GACRI-MILLGOM



500B, SOPORTE CAJA FIAT DUNA-UNO,
GACRI-MILLGOM



1077, SOPORTE CAJA FIAT DUNA-UNO 1.3
DIESEL, GACRI-MILLGOM



1084, SOPORTE CAJA FIAT
DUNA-UNO-WEEKEND 1.7 DIESEL,
GACRI-MILLGOM



5159, SOPORTE CAJA FIAT PALIO 1.8,
GACRI-MILLGOM



1107, SOPORTE CAJA FIAT PALIO-SIENA,
GACRI-MILLGOM



5158, SOPORTE CAJA FIAT UNO 1.3 FIRE,
GACRI-MILLGOM



551, SOPORTE CAJA FORD 14000 MOTOR
MWM, GACRI-MILLGOM



524, SOPORTE CAJA FORD CON MOTOR
PERKINS, GACRI-MILLGOM



570, SOPORTE CAJA FORD ESCORT '96,
GACRI-MILLGOM



558, SOPORTE CAJA FORD F100 4.9
NAFTA INYECCION, GACRI-MILLGOM



526, SOPORTE CAJA FORD F100 4X4
F250-350 MOTOR PERKINS,
GACRI-MILLGOM



557, SOPORTE CAJA FORD F100
4X4-RANGER SIMPLE-DOBLE 88/97 CAJA
MAZDA, GACRI-MILLGOM



555, SOPORTE CAJA FORD F100 CAJA
CLARK, GACRI-MILLGOM



587, SOPORTE CAJA FORD F100 DIESEL
MOTOR MWM Y NAFTA 4.2,
GACRI-MILLGOM



588, SOPORTE CAJA FORD F100 MOTOR
CUMMINS, GACRI-MILLGOM



550, SOPORTE CAJA FORD F100-150-14000
MOTOR MWM, GACRI-MILLGOM



515, SOPORTE CAJA FORD F100 '69 2º
SERIE, GACRI-MILLGOM



505, SOPORTE CAJA FORD FALCON
188-221 '82, GACRI-MILLGOM

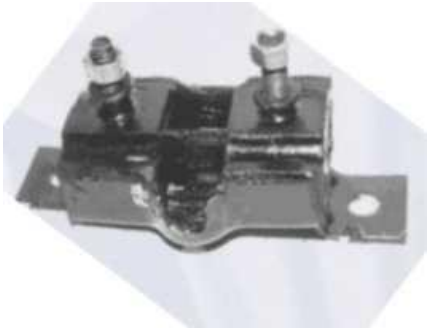

541, SOPORTE CAJA FORD FALCON 4 CIL., GACRI-MILLGOM



503, SOPORTE CAJA FORD FALCON 62/80, GACRI-MILLGOM



503B, SOPORTE CAJA FORD FALCON 62/80 (FLEJE CON TUERCA), GACRI-MILLGOM



578, SOPORTE CAJA FORD FIESTA NAFTA-DIESEL, GACRI-MILLGOM



531, SOPORTE CAJA FORD SIERRA, GACRI-MILLGOM



512, SOPORTE CAJA FORD TAUNUS 2.0-2.3, GACRI-MILLGOM



3205, SOPORTE CAJA FORD TRANSIT DIESEL, GACRI-MILLGOM



504, SOPORTE CAJA INFERIOR FORD FALCON, GACRI-MILLGOM



623, SOPORTE CAJA MERCEDES BENZ SPRINTER, GACRI-MILLGOM



806, SOPORTE CAJA PEUGEOT 404-504 DIESEL, GACRI-MILLGOM



805, SOPORTE CAJA PEUGEOT 404-504 NAFTA, GACRI-MILLGOM



820, SOPORTE CAJA PEUGEOT 504-505 DIESEL CAJA 5° 90 AD., GACRI-MILLGOM



823, SOPORTE CAJA PEUGEOT 504-505
GAMMA S.80 DIESEL, GACRI-MILLGOM



822, SOPORTE CAJA PEUGEOT 504-505
GAMMA S.80 NAFTA, GACRI-MILLGOM



819, SOPORTE CAJA PEUGEOT 504-505
NAFTA CAJA 5° 90 AD., GACRI-MILLGOM



908, SOPORTE CAJA RASTROJERO,
GACRI-MILLGOM



907, SOPORTE CAJA RASTROJERO
CABURE P63, GACRI-MILLGOM



1033, SOPORTE CAJA RENAULT 12,
GACRI-MILLGOM



1039, SOPORTE CAJA RENAULT 12-18/1400
CAJA 5°, GACRI-MILLGOM



1041, SOPORTE CAJA RENAULT 18/2000,
GACRI-MILLGOM



1053, SOPORTE CAJA RENAULT 21,
GACRI-MILLGOM



1025, SOPORTE CAJA RENAULT 4S-6,
GACRI-MILLGOM



1018, SOPORTE CAJA RENAULT
DAUPHINE-GORDINI, GACRI-MILLGOM



1003A, SOPORTE CAJA RENAULT IKA
JEEP-ESTANCIERA-GLADIATOR
(ORIGINAL), GACRI-MILLGOM



1003, SOPORTE CAJA RENAULT IKA JEEP-ESTANCIERA-GLADIATOR (REFORMA), GACRI-MILLGOM



1013A, SOPORTE CAJA RENAULT IKA JEEP-RAMBLER 1962, GACRI-MILLGOM



1014, SOPORTE CAJA RENAULT IKA JEEP-RAMBLER 1963, GACRI-MILLGOM



1016, SOPORTE CAJA RENAULT IKA JEEP-RAMBLER 64/67, GACRI-MILLGOM



1017A, SOPORTE CAJA RENAULT TORINO, GACRI-MILLGOM



2312, SOPORTE CAJA RENAULT TRAFIC CAJA 4º, GACRI-MILLGOM



2126, SOPORTE CAJA RENAULT TRAFIC DIESEL '99 AD., GACRI-MILLGOM



1047, SOPORTE CAJA RENAULT TRAFIC NAFTA-DIESEL CAJA 5º, GACRI-MILLGOM



313, SOPORTE CAJA SIAM DI TELLA, GACRI-MILLGOM



3004, SOPORTE CAJA TOYOTA HILUX DOBLE TRACCION, GACRI-MILLGOM



3003, SOPORTE CAJA TOYOTA HILUX SIMPLE TRACCION, GACRI-MILLGOM



350, SOPORTE CAJA TRASERO VW KOMBI, GACRI-MILLGOM



320, SOPORTE CAJA VW DODGE 1500,
GACRI-MILLGOM



324, SOPORTE CAJA VW DODGE D100
64/65 MOTOR VALIANT, GACRI-MILLGOM



325, SOPORTE CAJA VW DODGE D100
64/65 MOTOR VALIANT CON BULON,
GACRI-MILLGOM



326, SOPORTE CAJA VW DODGE
D100-D400, GACRI-MILLGOM



333, SOPORTE CAJA VW DODGE VALIANT,
GACRI-MILLGOM



340, SOPORTE CAJA VW GACEL-PASSAT
CAJA 4º, GACRI-MILLGOM



346, SOPORTE CAJA VW
GOL-GACEL-SAVEIRO-SENDA,
GACRI-MILLGOM



619, SOPORTE CARDAN MERCEDES BENZ
1517, GACRI-MILLGOM



622, SOPORTE CARDAN MERCEDES BENZ
1517-1518, GACRI-MILLGOM



247, SOPORTE CARROCERIA (ALMOHADILLA) CHEVROLET CAMION '66 AD., GACRI-MILLGOM



529, SOPORTE CARROCERIA FORD F100 61/73 (JUEGO), GACRI-MILLGOM



521, SOPORTE CARROCERIA INFERIOR FORD F100, GACRI-MILLGOM



522, SOPORTE CARROCERIA INFERIOR FORD F100, GACRI-MILLGOM



244, SOPORTE CARROCERIA INTERMEDIO (ALMOHADILLA) CHEVROLET, GACRI-MILLGOM



563, SOPORTE CARROCERIA INTERMEDIO (ALMOHADILLA) FORD, GACRI-MILLGOM



519, SOPORTE CARROCERIA SUPERIOR FORD F100, GACRI-MILLGOM



520, SOPORTE CARROCERIA SUPERIOR FORD F100, GACRI-MILLGOM



322, SOPORTE CAZOLETA AMORTIGUADOR VW DODGE 1500 CON RULEMAN, GACRI-MILLGOM



322A, SOPORTE CAZOLETA AMORTIGUADOR VW DODGE 1500 SIN RULEMAN, GACRI-MILLGOM



1052, SOPORTE CENTRAL CAJA RENAULT 9-11, GACRI-MILLGOM



1021, SOPORTE CENTRAL EMPUJE RENAULT 4L, GACRI-MILLGOM



281, Soporte de motor derecho Chevrolet Aveo, GACRI-MILLGOM



3172, Soporte de motor derecho Ford Escort, GACRI-MILLGOM

3188, Soporte de motor derecho Ford Fiesta-Ecosport 1.6 Rocam, GACRI-MILLGOM



5169, SOPORTE DE MOTOR FIAT PALIO-SIENA 1.4 IZQUIERDO, GACRI-MILLGOM



280, Soporte de motor izquierdo Chevrolet Aveo, GACRI-MILLGOM

262, Soporte de motor izquierdo Chevrolet Corsa II-Meriva, GACRI-MILLGOM



262H, Soporte de motor izquierdo Chevrolet Corsa II-Meriva (Hidraulico), GACRI-MILLGOM



418, SOPORTE ELASTICO DELANTERO FIAT 600, GACRI-MILLGOM



421, SOPORTE ELASTICO DELANTERO FIAT 600, GACRI-MILLGOM



497, SOPORTE ELASTICO FIAT 147-DUNA-UNO, GACRI-MILLGOM



455, SOPORTE ELASTICO FIAT 147-DUNA-UNO-REGATTA, GACRI-MILLGOM



1026, SOPORTE ELASTICO RENAULT 4L, GACRI-MILLGOM



236, SOPORTE ELASTICO TRASERO BEDFORD, GACRI-MILLGOM



454, SOPORTE ELASTICO TRASERO FIAT 128, GACRI-MILLGOM



234, SOPORTE GOMA RULEMAN 6207 CHEVROLET ORIGINAL, GACRI-MILLGOM



361, SOPORTE GOMA RULEMAN 6207 VW DODGE (REFORMA), GACRI-MILLGOM



118, SOPORTE GOMA RULEMAN 6208 BEDFORD (REFORMA), GACRI-MILLGOM



117, SOPORTE GOMA RULEMAN 6208 BEDFORD ORIGINAL, GACRI-MILLGOM



119, SOPORTE GOMA RULEMAN 6209
BEDFORD (REFORMA), GACRI-MILLGOM



115A, SOPORTE GOMA RULEMAN 6209
BEDFORD ORIGINAL '62, GACRI-MILLGOM



116, SOPORTE GOMA RULEMAN 6209
BEDFORD ORIGINAL '62, GACRI-MILLGOM



225, SOPORTE INFERIOR DELANTERO
CABINA CHEVROLET PICK UP 63/67,
GACRI-MILLGOM



8051, SOPORTE INTERMEDIO BARRA
ESTAB. RENAULT 19-MEGANE,
GACRI-MILLGOM



267, Soporte lado derecho Chevrolet Corsa
II-Meriva, GACRI-MILLGOM



1056, SOPORTE MOTOR CENTRAL CAJA
RENAULT 19-CLIO-MEGANE,
GACRI-MILLGOM



582, SOPORTE MOTOR CENTRAL FORD
FIESTA DIESEL, GACRI-MILLGOM



581, SOPORTE MOTOR CENTRAL FORD
FIESTA NAFTA, GACRI-MILLGOM



3161, SOPORTE MOTOR CENTRAL FORD FOCUS DIESEL, GACRI-MILLGOM



3162, SOPORTE MOTOR CENTRAL FORD FOCUS NAFTA, GACRI-MILLGOM



1038, SOPORTE MOTOR CENTRAL INFERIOR RENAULT 18-FUEGO NAFTA-DIESEL, GACRI-MILLGOM



3383, SOPORTE MOTOR CENTRAL PEUGEOT 206 DIESEL, GACRI-MILLGOM



4127, SOPORTE MOTOR CENTRAL RENAULT LAGUNA NAFTA-DIESEL, GACRI-MILLGOM



4126, SOPORTE MOTOR CENTRAL RENAULT TWINGO 1.4, GACRI-MILLGOM



277, Soporte motor Chevrolet Astra-Meriva-Zafira, GACRI-MILLGOM



251, SOPORTE MOTOR CHEVROLET PICK UP C10, GACRI-MILLGOM



245, SOPORTE MOTOR CHEVROLET PICK UP D20 DIESEL, GACRI-MILLGOM



272, Soporte motor Chevrolet Vectra '94,
GACRI-MILLGOM



602, SOPORTE MOTOR
DEL.-TRAS.MERCEDES BENZ 911-1112-3500
(2 Ø), GACRI-MILLGOM



3861, SOPORTE MOTOR DEL.CENTRAL
VW POLO-CADDY NAFTA-DIESEL,
GACRI-MILLGOM



111, SOPORTE MOTOR DELANTERO
BEDFORD 57/76-CAMION 350'62 AD.,
GACRI-MILLGOM



549, SOPORTE MOTOR DELANTERO
CENTRAL FORD F14000 MOTOR MWM,
GACRI-MILLGOM



242, SOPORTE MOTOR DELANTERO
CHEVROLET 1955, GACRI-MILLGOM

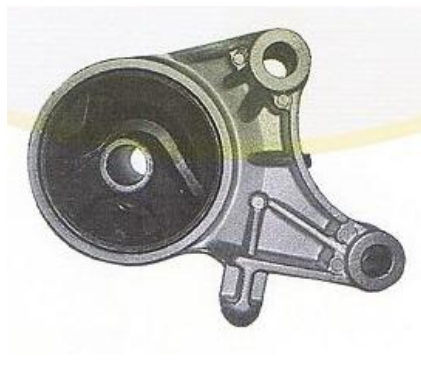

221, SOPORTE MOTOR DELANTERO
CHEVROLET 400, GACRI-MILLGOM



275, Soporte motor delantero Chevrolet Astra
'99 adel., GACRI-MILLGOM



274, Soporte motor delantero Chevrolet
Astra-Zafira 2.0 16v., GACRI-MILLGOM



241, SOPORTE MOTOR DELANTERO
CHEVROLET CAMION 33/46,
GACRI-MILLGOM

222, SOPORTE MOTOR DELANTERO
CHEVROLET CHEVY, GACRI-MILLGOM

228, SOPORTE MOTOR DELANTERO
CHEVROLET OPEL K180, GACRI-MILLGOM



223, SOPORTE MOTOR DELANTERO CHEVROLET PICK UP 63/65, GACRI-MILLGOM



233, SOPORTE MOTOR DELANTERO CHEVROLET PICK UP '74 AD., GACRI-MILLGOM



461, SOPORTE MOTOR DELANTERO FIAT 125-1600, GACRI-MILLGOM



478, SOPORTE MOTOR DELANTERO FIAT 1500, GACRI-MILLGOM



5126, SOPORTE MOTOR DELANTERO FIAT PALIO-SIENA DIESEL, GACRI-MILLGOM



1092, SOPORTE MOTOR DELANTERO FIAT PALIO-SIENA NAFTA, GACRI-MILLGOM



5127, SOPORTE MOTOR DELANTERO FIAT TEMPRA, GACRI-MILLGOM



567, SOPORTE MOTOR DELANTERO FORD ESCORT, GACRI-MILLGOM



514, SOPORTE MOTOR DELANTERO FORD F100 8 CIL.69/70, GACRI-MILLGOM

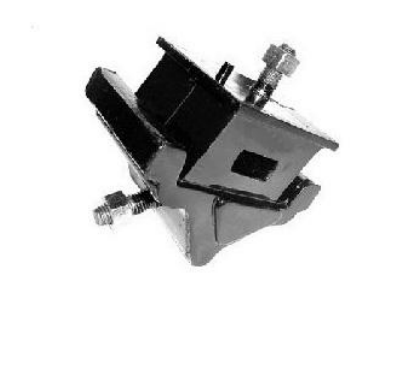

556, SOPORTE MOTOR DELANTERO FORD F100 DIESEL MOTOR MAXION, GACRI-MILLGOM



548, SOPORTE MOTOR DELANTERO FORD F14000 MOTOR MWM, GACRI-MILLGOM



523, SOPORTE MOTOR DELANTERO FORD F600-700-7000 6 CIL.MOTOR PERKINS, GACRI-MILLGOM



502, SOPORTE MOTOR DELANTERO FORD FALCON 70/78, GACRI-MILLGOM



501, SOPORTE MOTOR DELANTERO FORD FALCON HASTA '69, GACRI-MILLGOM



3202, SOPORTE MOTOR DELANTERO FORD FIESTA DIESEL, GACRI-MILLGOM



579, SOPORTE MOTOR DELANTERO FORD FIESTA DIESEL '96 AD.(NO HIDRAULICO), GACRI-MILLGOM



3201, SOPORTE MOTOR DELANTERO FORD FIESTA NAFTA, GACRI-MILLGOM



580, SOPORTE MOTOR DELANTERO FORD FIESTA NAFTA '96 AD.(NO HIDRAULICO), GACRI-MILLGOM

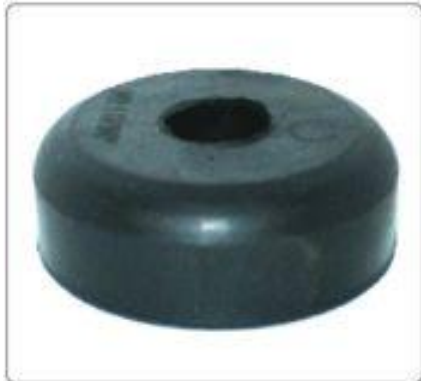

518, SOPORTE MOTOR DELANTERO INFERIOR FORD F100 PICK UP, GACRI-MILLGOM



311, SOPORTE MOTOR DELANTERO INFERIOR SIAM DI TELLA, GACRI-MILLGOM



265, Soporte motor delantero izquierdo Chevrolet Corsa II-Meriva, GACRI-MILLGOM



601, SOPORTE MOTOR DELANTERO MERCEDES BENZ 1112 (1 Ø), GACRI-MILLGOM



617, SOPORTE MOTOR DELANTERO MERCEDES BENZ 1517, GACRI-MILLGOM



611, SOPORTE MOTOR DELANTERO MERCEDES BENZ 170, GACRI-MILLGOM



620, SOPORTE MOTOR DELANTERO
MERCEDES BENZ MOTOR HPN,
GACRI-MILLGOM



624, SOPORTE MOTOR DELANTERO
MERCEDES BENZ SPRINTER,
GACRI-MILLGOM



801, SOPORTE MOTOR DELANTERO
PEUGEOT 403-404, GACRI-MILLGOM



803, SOPORTE MOTOR DELANTERO
PEUGEOT 504-505 NAFTA-DIESEL,
GACRI-MILLGOM



804, SOPORTE MOTOR DELANTERO
PEUGEOT 504-505 NAFTA-DIESEL,
GACRI-MILLGOM



904, SOPORTE MOTOR DELANTERO
RASTROJERO ALTO, GACRI-MILLGOM



903, SOPORTE MOTOR DELANTERO
RASTROJERO BAJO, GACRI-MILLGOM



905, SOPORTE MOTOR DELANTERO
RASTROJERO CABURE P63 ORIGINAL,
GACRI-MILLGOM



906, SOPORTE MOTOR DELANTERO
RASTROJERO CABURE P63 REFORMA,
GACRI-MILLGOM



901, SOPORTE MOTOR DELANTERO RASTROJERO INDENOR, GACRI-MILLGOM



902, SOPORTE MOTOR DELANTERO RASTROJERO INDENOR 6 CIL., GACRI-MILLGOM



1032, SOPORTE MOTOR DELANTERO RENAULT 12, GACRI-MILLGOM



1040, SOPORTE MOTOR DELANTERO RENAULT 18/1400/1600, GACRI-MILLGOM



1002, SOPORTE MOTOR DELANTERO RENAULT IKA ESTANCIERA (REFORMA), GACRI-MILLGOM



1001, SOPORTE MOTOR DELANTERO RENAULT IKA ESTANCIERA ALTO, GACRI-MILLGOM



1008, SOPORTE MOTOR DELANTERO RENAULT IKA JEEP (BAJO), GACRI-MILLGOM



1009, SOPORTE MOTOR DELANTERO RENAULT IKA JEEP (REFORMA), GACRI-MILLGOM



1013, SOPORTE MOTOR DELANTERO RENAULT IKA JEEP-RAMBLER, GACRI-MILLGOM



1017, SOPORTE MOTOR DELANTERO
RENAULT TORINO, GACRI-MILLGOM



1046, SOPORTE MOTOR DELANTERO
RENAULT TRAFIC 1400, GACRI-MILLGOM



1045, SOPORTE MOTOR DELANTERO
RENAULT TRAFIC 2000, GACRI-MILLGOM



1059, SOPORTE MOTOR DELANTERO
RENAULT TRAFIC NAFTA-DIESEL '93 AD.,
GACRI-MILLGOM



312, SOPORTE MOTOR DELANTERO SIAM
DI TELLA MAGNETTE, GACRI-MILLGOM



517, SOPORTE MOTOR DELANTERO
SUPERIOR FORD F100 PICK UP,
GACRI-MILLGOM



310, SOPORTE MOTOR DELANTERO
SUPERIOR SIAM DI TELLA,
GACRI-MILLGOM



329, SOPORTE MOTOR DELANTERO VW
DODGE D100-D200 CON PERKINS,
GACRI-MILLGOM



328, SOPORTE MOTOR DELANTERO VW
DODGE D100-D400 1960, GACRI-MILLGOM



353, SOPORTE MOTOR DELANTERO VW POLO-POINTER C/A.A., GACRI-MILLGOM



327, SOPORTE MOTOR DELANTERO Y TRASERO VW DODGE D100-D400, GACRI-MILLGOM

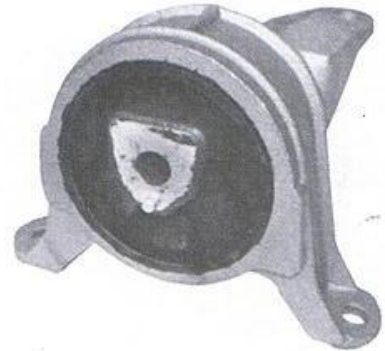

276, Soporte motor derecho Chevrolet Astra-Zafira 2.0, GACRI-MILLGOM

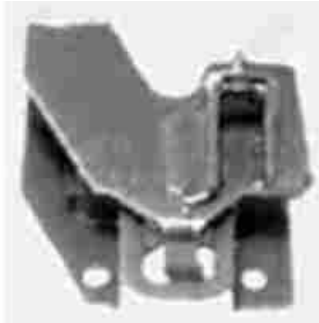

249, SOPORTE MOTOR DERECHO CHEVROLET BLAZER-S10, GACRI-MILLGOM



254, SOPORTE MOTOR DERECHO CHEVROLET CORSA NAFTA CON AIRE, GACRI-MILLGOM



252, SOPORTE MOTOR DERECHO CHEVROLET CORSA-MONZA 1.6, GACRI-MILLGOM



257, SOPORTE MOTOR DERECHO CHEVROLET CORSA-TIGRA, GACRI-MILLGOM



1089, SOPORTE MOTOR DERECHO FIAT 147-FIORINO, GACRI-MILLGOM



1082, SOPORTE MOTOR DERECHO FIAT 147-SPAZIO DIESEL, GACRI-MILLGOM



1085, SOPORTE MOTOR DERECHO FIAT DUNA-WEEKEND 1.7 DIESEL, GACRI-MILLGOM



1104, SOPORTE MOTOR DERECHO FIAT TIPO, GACRI-MILLGOM



3143, SOPORTE MOTOR DERECHO FORD ESCORT DIESEL, GACRI-MILLGOM

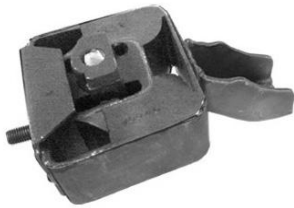

3421, SOPORTE MOTOR DERECHO FORD F100 4.9 NAFTA, GACRI-MILLGOM

576, SOPORTE MOTOR DERECHO FORD FIESTA NAFTA, GACRI-MILLGOM

575, SOPORTE MOTOR DERECHO FORD FIESTA NAFTA-DIESEL, GACRI-MILLGOM



3158, SOPORTE MOTOR DERECHO FORD KA, GACRI-MILLGOM

3157, SOPORTE MOTOR DERECHO FORD KA '99 AD., GACRI-MILLGOM

3168, SOPORTE MOTOR DERECHO FORD MONDEO DIESEL, GACRI-MILLGOM



1966, SOPORTE MOTOR DERECHO FORD RANGER 2.5 DIESEL, GACRI-MILLGOM

832, SOPORTE MOTOR DERECHO PEUGEOT 405 (HIDRAULICO), GACRI-MILLGOM

828, SOPORTE MOTOR DERECHO PEUGEOT 405 (NO HIDRAULICO), GACRI-MILLGOM



870, SOPORTE MOTOR DERECHO PEUGEOT 405-605 DT1, GACRI-MILLGOM

1036, SOPORTE MOTOR DERECHO RENAULT 18/2000-FUEGO, GACRI-MILLGOM

1898H, SOPORTE MOTOR DERECHO RENAULT 19 DIESEL (HIDRAULICO), GACRI-MILLGOM



1898, SOPORTE MOTOR DERECHO
RENAULT 19 DIESEL (NO HIDRAULICO),
GACRI-MILLGOM



1058, SOPORTE MOTOR DERECHO
RENAULT 19-CLIO-MEGANE-KANGOO,
GACRI-MILLGOM



1049, SOPORTE MOTOR DERECHO
RENAULT 21, GACRI-MILLGOM



1022, SOPORTE MOTOR DERECHO
RENAULT 4L, GACRI-MILLGOM



1029, SOPORTE MOTOR DERECHO
RENAULT 4S-6, GACRI-MILLGOM



1050, SOPORTE MOTOR DERECHO
RENAULT 9-11, GACRI-MILLGOM



2105H, SOPORTE MOTOR DERECHO
RENAULT CLIO-EXPRESS DIESEL
(HIDRAULICO), GACRI-MILLGOM



2105, SOPORTE MOTOR DERECHO
RENAULT CLIO-EXPRESS DIESEL (NO
HIDRAULICO), GACRI-MILLGOM



1020, SOPORTE MOTOR DERECHO
RENAULT DAUPHINE-GORDINI,
GACRI-MILLGOM



2113H, SOPORTE MOTOR DERECHO RENAULT KANGOO (HIDRAULICO), GACRI-MILLGOM



2113, SOPORTE MOTOR DERECHO RENAULT KANGOO (NO HIDRAULICO), GACRI-MILLGOM



4117, SOPORTE MOTOR DERECHO RENAULT LAGUNA NAFTA-DIESEL, GACRI-MILLGOM



2125, SOPORTE MOTOR DERECHO RENAULT MASTER, GACRI-MILLGOM



2310, SOPORTE MOTOR DERECHO RENAULT MEGANE 1.6-CLIO II (HIDRAULICO), GACRI-MILLGOM



2309, SOPORTE MOTOR DERECHO RENAULT MEGANE 1.6-CLIO II (NO HIDRAULICO), GACRI-MILLGOM



2108H, SOPORTE MOTOR DERECHO RENAULT MEGANE 2000 (HIDRAULICO), GACRI-MILLGOM



2108, SOPORTE MOTOR DERECHO RENAULT MEGANE 2000 (NO HIDRAULICO), GACRI-MILLGOM



4124, SOPORTE MOTOR DERECHO RENAULT TWINGO 1.1, GACRI-MILLGOM



332, SOPORTE MOTOR DERECHO VW DODGE VALIANT, GACRI-MILLGOM



591, SOPORTE MOTOR DERECHO-IZQUIERDO FORD TRANSIT (HIDRAULICO), GACRI-MILLGOM



590, SOPORTE MOTOR DERECHO-IZQUIERDO FORD TRANSIT (NO HIDRAULICO), GACRI-MILLGOM



1063, SOPORTE MOTOR FIAT DUNA-UNO DIESEL, GACRI-MILLGOM



1065, SOPORTE MOTOR FIAT DUNA-UNO NAFTA, GACRI-MILLGOM



5152, SOPORTE MOTOR FIAT PALIO-SIENA '01 AD., GACRI-MILLGOM



1094, SOPORTE MOTOR FIAT REGATTA 85, GACRI-MILLGOM



1095, SOPORTE MOTOR FIAT REGATTA SC, GACRI-MILLGOM



3142, SOPORTE MOTOR FORD ESCORT DIESEL, GACRI-MILLGOM



589, SOPORTE MOTOR FORD F100 MOTOR CUMMINS 96/98-CARGO 915 MWM, GACRI-MILLGOM



546, SOPORTE MOTOR FORD F100-150 MOTOR MWM, GACRI-MILLGOM



516, SOPORTE MOTOR FORD F100-F350 MOTOR PERKINS, GACRI-MILLGOM



510, SOPORTE MOTOR FORD FALCON-F100-FAIRLANE 6 CIL. '80, GACRI-MILLGOM



507, SOPORTE MOTOR FORD FALCON-TAUNUS 2.3 4 CIL. '82 AD., GACRI-MILLGOM



511, SOPORTE MOTOR FORD TAUNUS 2.0-2.3, GACRI-MILLGOM



273, Soporte motor izquierdo Chevrolet Astra-Zafira 2.0, GACRI-MILLGOM



273H, Soporte motor izquierdo Chevrolet Astra-Zafira 2.0 (hidraulico), GACRI-MILLGOM



248, SOPORTE MOTOR IZQUIERDO CHEVROLET BLAZER-S10, GACRI-MILLGOM



255, SOPORTE MOTOR IZQUIERDO CHEVROLET CORSA 1.4-1.6 NAFTA, GACRI-MILLGOM



253, SOPORTE MOTOR IZQUIERDO CHEVROLET CORSA-MONZA 1.6, GACRI-MILLGOM



1090, SOPORTE MOTOR IZQUIERDO FIAT 147-FIORINO, GACRI-MILLGOM



1081, SOPORTE MOTOR IZQUIERDO FIAT 147-SPAZIO DIESEL, GACRI-MILLGOM



1086, SOPORTE MOTOR IZQUIERDO FIAT DUNA-WEEKEND 1.7 DIESEL, GACRI-MILLGOM



5160, SOPORTE MOTOR IZQUIERDO FIAT PALIO 1.8, GACRI-MILLGOM



3422, SOPORTE MOTOR IZQUIERDO FORD F100 4.9 NAFTA, GACRI-MILLGOM



577, SOPORTE MOTOR IZQUIERDO FORD FIESTA DIESEL, GACRI-MILLGOM

3163, SOPORTE MOTOR IZQUIERDO FORD FOCUS (NO HIDRAULICO), GACRI-MILLGOM



3159, SOPORTE MOTOR IZQUIERDO FORD KA, GACRI-MILLGOM



3144, SOPORTE MOTOR IZQUIERDO FORD MONDEO DIESEL, GACRI-MILLGOM



3167, SOPORTE MOTOR IZQUIERDO FORD MONDEO DIESEL, GACRI-MILLGOM



3145, SOPORTE MOTOR IZQUIERDO FORD MONDEO NAFTA, GACRI-MILLGOM



1965, SOPORTE MOTOR IZQUIERDO FORD RANGER 2.5 DIESEL, GACRI-MILLGOM



839, SOPORTE MOTOR IZQUIERDO PEUGEOT 106-206, GACRI-MILLGOM



853, SOPORTE MOTOR IZQUIERDO PEUGEOT 205-405, GACRI-MILLGOM



840, SOPORTE MOTOR IZQUIERDO PEUGEOT 306, GACRI-MILLGOM



829, SOPORTE MOTOR IZQUIERDO PEUGEOT 405, GACRI-MILLGOM



1037, SOPORTE MOTOR IZQUIERDO RENAULT 18/2000-FUEGO, GACRI-MILLGOM



2103, SOPORTE MOTOR IZQUIERDO RENAULT 19 DIESEL-MEGANE 2000, GACRI-MILLGOM



1057, SOPORTE MOTOR IZQUIERDO RENAULT 19-CLIO-MEGANE, GACRI-MILLGOM



1055, SOPORTE MOTOR IZQUIERDO
RENAULT 21, GACRI-MILLGOM



1023, SOPORTE MOTOR IZQUIERDO
RENAULT 4L, GACRI-MILLGOM

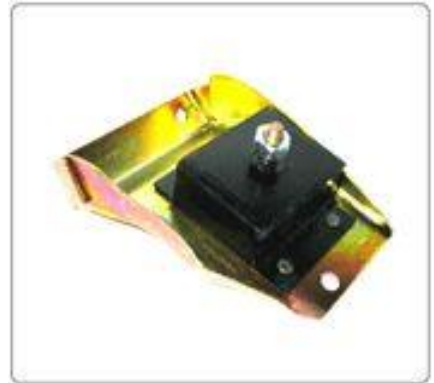

1030, SOPORTE MOTOR IZQUIERDO
RENAULT 4S-6, GACRI-MILLGOM



1051, SOPORTE MOTOR IZQUIERDO
RENAULT 9-11, GACRI-MILLGOM



1019, SOPORTE MOTOR IZQUIERDO
RENAULT DAUPHINE-GORDINI,
GACRI-MILLGOM



4099, SOPORTE MOTOR IZQUIERDO
RENAULT ESPRESS DIESEL,
GACRI-MILLGOM



2124, SOPORTE MOTOR IZQUIERDO
RENAULT MASTER, GACRI-MILLGOM



331, SOPORTE MOTOR IZQUIERDO VW
DODGE VALIANT, GACRI-MILLGOM



352, SOPORTE MOTOR IZQUIERDO VW
POLO-POINTER, GACRI-MILLGOM

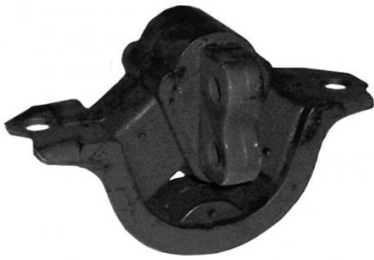

256, SOPORTE MOTOR LADO CAJA CHEVROLET CORSA 1.7 DIESEL, GACRI-MILLGOM



5153, SOPORTE MOTOR LADO CAJA FIAT PALIO 1.3 MPI FIRE FASE II, GACRI-MILLGOM



5155, SOPORTE MOTOR LADO CAJA FIAT PALIO HLX-ELX, GACRI-MILLGOM



1093, SOPORTE MOTOR LADO CAJA FIAT PALIO-SIENA, GACRI-MILLGOM



5161, SOPORTE MOTOR LADO CAJA FIAT PALIO-SIENA '01 AD., GACRI-MILLGOM



1101, SOPORTE MOTOR LADO CAJA FIAT TEMPRA, GACRI-MILLGOM



597, SOPORTE MOTOR LADO CAJA FORD ESCORT, GACRI-MILLGOM



3160, SOPORTE MOTOR LADO CAJA FORD KA, GACRI-MILLGOM



584, SOPORTE MOTOR LADO CAJA FORD SIERRA 1.6 S/A.A., GACRI-MILLGOM



585, SOPORTE MOTOR LADO CAJA FORD SIERRA 1.6-2.3, GACRI-MILLGOM



586, SOPORTE MOTOR LADO CAJA FORD SIERRA 1.6-2.3 C/A.A.(HIDRAULICO), GACRI-MILLGOM



2112, SOPORTE MOTOR LADO CAJA RENAULT 19-CLIO-EXPRESS DIESEL (50 MM.), GACRI-MILLGOM



2111, SOPORTE MOTOR LADO CAJA
RENAULT CLIO-EXPRESS DIESEL (40 MM.),
GACRI-MILLGOM



2114, SOPORTE MOTOR LADO CAJA
RENAULT KANGOO 1.9 DIESEL,
GACRI-MILLGOM



3886H, SOPORTE MOTOR LADO CAJA VW
POLO-CADDY NAFTA-DIESEL
(HIDRAULICO), GACRI-MILLGOM



270, Soporte motor lado derecho cuello recto
Chevrolet Vectra, GACRI-MILLGOM



270H, Soporte motor lado derecho cuello
recto Chevrolet Vectra (hidraulico),
GACRI-MILLGOM

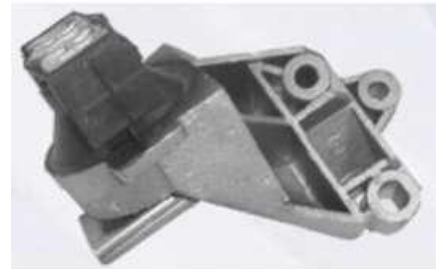

4125, SOPORTE MOTOR LADO DISTRIB.
RENAULT TWINGO 1.1, GACRI-MILLGOM



3862, SOPORTE MOTOR LADO DISTRIB.VW
POLO-CADDY NAFTA-DIESEL,
GACRI-MILLGOM



269, Soporte motor lado izquierdo cuello curvo
Chevrolet Vectra, GACRI-MILLGOM



269H, Soporte motor lado izquierdo cuello
curvo Chevrolet Vectra (hidraulico),
GACRI-MILLGOM



271, Soporte motor lado izquierdo cuello curvo Chevrolet Vectra caja autom., GACRI-MILLGOM



271H, Soporte motor lado izquierdo cuello curvo Chevrolet Vectra caja autom. (hidraulico), GACRI-MILLGOM



533, SOPORTE MOTOR LATERAL FORD F100 MOTOR PERKINS (CERRADO), GACRI-MILLGOM



545, SOPORTE MOTOR LATERAL FORD F100 MOTOR PERKINS (CERRADO), GACRI-MILLGOM



534, SOPORTE MOTOR LATERAL FORD F100 MOTOR PERKINS (CON Ø), GACRI-MILLGOM



544, SOPORTE MOTOR LATERAL FORD F100 MOTOR PERKINS (CON Ø), GACRI-MILLGOM



1015, SOPORTE MOTOR LATERAL RENAULT IKA JEEP-RAMBLER 63/67, GACRI-MILLGOM



841, SOPORTE MOTOR PEUGEOT 206-306-406 (HIDRAULICO), GACRI-MILLGOM



859, SOPORTE MOTOR PEUGEOT 307 1.6 16V.NAFTA, GACRI-MILLGOM



858, SOPORTE MOTOR PEUGEOT 307 2.0 HDI, GACRI-MILLGOM



857, SOPORTE MOTOR PEUGEOT 307 2.0 NAFTA, GACRI-MILLGOM



848, SOPORTE MOTOR PEUGEOT 505 DIESEL, GACRI-MILLGOM





2106H, SOPORTE MOTOR RENAULT CLIO-EXPRESS DIESEL (HIDRAULICO), GACRI-MILLGOM



2106, SOPORTE MOTOR RENAULT CLIO-EXPRESS DIESEL (NO HIDRAULICO), GACRI-MILLGOM



4113, SOPORTE MOTOR RENAULT LAGUNA (HIDRAULICO), GACRI-MILLGOM



4112, SOPORTE MOTOR RENAULT LAGUNA (NO HIDRAULICO), GACRI-MILLGOM

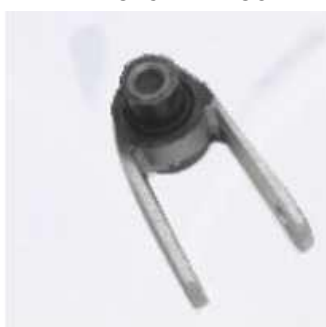

4128, SOPORTE MOTOR RENAULT LAGUNA RXE MOTOR N7Q, GACRI-MILLGOM



5154, SOPORTE MOTOR SUP.DERECHO FIAT UNO-PALIO-SIENA MOTOR FIRE, GACRI-MILLGOM

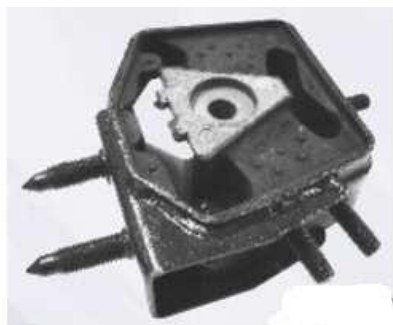

3149, SOPORTE MOTOR SUPERIOR FORD ORION 1.8-2.0, GACRI-MILLGOM



2104, SOPORTE MOTOR SUPERIOR RENAULT CLIO NAFTA, GACRI-MILLGOM



3001, SOPORTE MOTOR TOYOTA HILUX 2.4-2.8 DIESEL, GACRI-MILLGOM



3002, SOPORTE MOTOR TOYOTA HILUX CON MOTOR 5L, GACRI-MILLGOM



2128, SOPORTE MOTOR TRAS.CENTRAL RENAULT CLIO II-MEGANE 1.6-SCENIC II, GACRI-MILLGOM



2127, SOPORTE MOTOR TRAS.CENTRAL RENAULT MASTER, GACRI-MILLGOM



8179, Soporte motor tras.inf. Renault Megane II-Scenic II-Logan, GACRI-MILLGOM



110, SOPORTE MOTOR TRASERO BEDFORD 57/76-CAMION 350'62 AD., GACRI-MILLGOM



114, SOPORTE MOTOR TRASERO BEDFORD ORIGINAL '57, GACRI-MILLGOM



560, SOPORTE MOTOR TRASERO DERECHO FORD ESCORT, GACRI-MILLGOM



561, SOPORTE MOTOR TRASERO DERECHO FORD ESCORT 1.8, GACRI-MILLGOM



562, SOPORTE MOTOR TRASERO DERECHO FORD ESCORT 1.8 XR3, GACRI-MILLGOM



571, SOPORTE MOTOR TRASERO FORD ESCORT '96, GACRI-MILLGOM



568, SOPORTE MOTOR TRASERO FORD FIESTA NAFTA, GACRI-MILLGOM



420, SOPORTE MOTOR TRASERO INFERIOR FIAT 600, GACRI-MILLGOM



564, SOPORTE MOTOR TRASERO IZQUIERDO FORD ESCORT, GACRI-MILLGOM



565, SOPORTE MOTOR TRASERO IZQUIERDO FORD ESCORT 1.8, GACRI-MILLGOM



603, SOPORTE MOTOR TRASERO MERCEDES BENZ 1112-1114 (3 Ø), GACRI-MILLGOM



618, SOPORTE MOTOR TRASERO MERCEDES BENZ 1517, GACRI-MILLGOM



621, SOPORTE MOTOR TRASERO MERCEDES BENZ MOTOR HPN, GACRI-MILLGOM



4098, SOPORTE MOTOR TRASERO RENAULT ESPRESS DIESEL, GACRI-MILLGOM



419, SOPORTE MOTOR TRASERO SUPERIOR FIAT 600, GACRI-MILLGOM



321, SOPORTE MOTOR VW DODGE 1500, GACRI-MILLGOM



323, SOPORTE MOTOR VW DODGE D100-D400 MOTOR VALIANT, GACRI-MILLGOM



341, SOPORTE MOTOR VW
GACEL-CARAT-GOL-SENDA-SAVEIRO-PASSAT,
GACRI-MILLGOM



2599, SOPORTE PARRILLA DELANTERO
PEUGEOT 406, GACRI-MILLGOM



5146, SOPORTE PARRILLA DERECHO
FIAT PALIO-SIENA BASE,
GACRI-MILLGOM



5156, SOPORTE PARRILLA DERECHO FIAT
PALIO-SIENA FIRE, GACRI-MILLGOM



5142, SOPORTE PARRILLA DERECHO FIAT
PALIO-SIENA FULL, GACRI-MILLGOM



5147, SOPORTE PARRILLA IZQUIERDO
FIAT PALIO-SIENA BASE, GACRI-MILLGOM



5157, SOPORTE PARRILLA IZQUIERDO
FIAT PALIO-SIENA FIRE, GACRI-MILLGOM



5143, SOPORTE PARRILLA IZQUIERDO
FIAT PALIO-SIENA FULL, GACRI-MILLGOM



8050, SOPORTE PUNTA BARRA ESTAB.
RENAULT 19-MEGANE, GACRI-MILLGOM



240, SOPORTE RADIADOR ALMOHADILLA
BEDFORD CHEVROLET CAMION-PICK UP,
GACRI-MILLGOM



530, SOPORTE RADIADOR FORD F100
61/71 (JUEGO), GACRI-MILLGOM



238, SOPORTE RADIADOR INFERIOR
BEDFORD CHEVROLET CAMION,
GACRI-MILLGOM



614, SOPORTE RADIADOR MERCEDES BENZ 1112-1114, GACRI-MILLGOM



237, SOPORTE RADIADOR SUPERIOR BEDFORD CHEVROLET CAMION, GACRI-MILLGOM



343, SOPORTE RADIADOR VW GOL-GACEL-SAVEIRO-SENDA (CHICO), GACRI-MILLGOM



342, SOPORTE RADIADOR VW GOL-GACEL-SAVEIRO-SENDA (GRANDE), GACRI-MILLGOM



314, SOPORTE REBOTE AMORTIGUADOR ELASTICO SIAM DI TELLA, GACRI-MILLGOM



224, SOPORTE SUPERIOR CABINA CHEVROLET PICK UP 67/73, GACRI-MILLGOM



594, SOPORTE SUPERIOR DELANTERO-TRASERO FORD 1946, GACRI-MILLGOM



1005, SOPORTE SUSPENSION DELANTERO RENAULT IKA ESTANCIERA, GACRI-MILLGOM



1004, SOPORTE SUSPENSION TRASERO RENAULT IKA ESTANCIERA, GACRI-MILLGOM



278, Soporte Tensor del.derecho Chevrolet Corsa m/viejo, GACRI-MILLGOM



279, Soporte Tensor del.izquierdo Chevrolet Corsa m/viejo, GACRI-MILLGOM

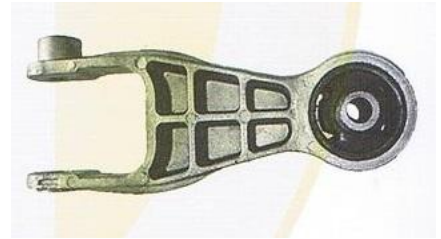

268, Soporte tensor inferior Chevrolet Corsa II-Meriva, GACRI-MILLGOM



2120, SOPORTE TENSOR LATERAL RENAULT KANGOO-MEGANE 2000, GACRI-MILLGOM



264, Soporte tensor superior Chevrolet Corsa II-Meriva, GACRI-MILLGOM



2118, SOPORTE TENSOR TRASERO RENAULT KANGOO 1.6 NAFTA, GACRI-MILLGOM

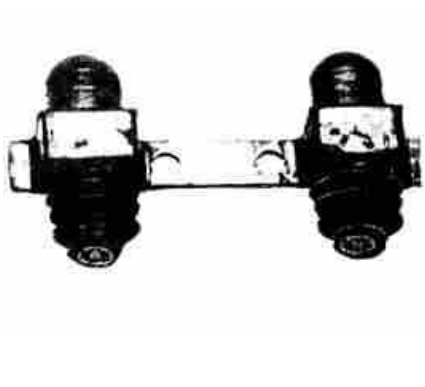

1069, SOPORTE TIRANTE PALANCA CAMBIOS FIAT DUNA-UNO (COMPLETO), GACRI-MILLGOM



532, SUPLEMENTO CARROCERIA FORD F100 (80 MM.), GACRI-MILLGOM



525, SUPLEMENTO SOPORTE CAJA FORD CON MOTOR PERKINS, GACRI-MILLGOM



1025A, SUPLEMENTO SOPORTE CAJA RENAULT 4S-6, GACRI-MILLGOM



2119, TACO REBOTE CENTRAL DERECHO RENAULT KANGOO-MEGANE-CLIO II 1.6 NAFTA, GACRI-MILLGOM



448, TENSOR ANCLAJE CURVO FIAT 128/1300, GACRI-MILLGOM



450, TENSOR ANCLAJE CURVO FIAT 128/1500, GACRI-MILLGOM



449, TENSOR ANCLAJE RECTO FIAT 128/1100, GACRI-MILLGOM



462, TENSOR DIFERENCIAL RECTO FIAT 125, GACRI-MILLGOM



1100, TOPE CAPOT FIAT DUNA-UNO, GACRI-MILLGOM



489, TOPE ELASTICO FIAT REGATTA 85-100, GACRI-MILLGOM



1062A, TOPE MARCHA ATRAS RENAULT 12, GACRI-MILLGOM



355, TOPE MOTOR DELANTERO VW GACEL, GACRI-MILLGOM



354, TOPE MOTOR DELANTERO VW GOL-GACEL-SAVEIRO-SENDA, GACRI-MILLGOM



831, TOPE MOTOR DERECHO PEUGEOT 405, GACRI-MILLGOM



4115, TOPE MOTOR RENAULT LAGUNA NAFTA, GACRI-MILLGOM



1035, TOPE PALANCA CAMBIOS RENAULT 12, GACRI-MILLGOM



365, TOPE REBOTE AMORTIGUADOR DELANTERO VW DODGE MOTOR PERKINS, GACRI-MILLGOM



426, TOPE RESPALDO ASIENTO DERECHO
FIAT 600, GACRI-MILLGOM



427, TOPE RESPALDO ASIENTO
IZQUIERDO FIAT 600, GACRI-MILLGOM



834, TOPE SOPORTE MOTOR DERECHO
PEUGEOT 405 DIESEL '93 AD.,
GACRI-MILLGOM



2107, TOPE SOPORTE MOTOR DERECHO
RENAULT 19 DIESEL, GACRI-MILLGOM



2109, TOPE SOPORTE MOTOR RENAULT
CLIO-EXPRESS (TODOS), GACRI-MILLGOM



2110, TOPE SOPORTE MOTOR RENAULT
MEGANE, GACRI-MILLGOM



824, TOPE SUSPENSION DELANTERO
PEUGEOT 404-504, GACRI-MILLGOM



1083, TOPE SUSPENSION FIAT
147-DUNA-UNO, GACRI-MILLGOM



609, UNION TOMA AIRE MERCEDES BENZ
CAMION 3500, GACRI-MILLGOM